

LIGHTING MANAGEMENT

AL SOLUTION



Advance Lighting management
빌딩 조명제어를 선도하는 다양한 시스템.
첨단 Lighting management solution의 중심에
에이엘솔루션이 있습니다.

디지털 조명제어 방식인 DALI
(Digital Addressable Lighting Interface)를
기반으로, 0-10V, Zigbee 무선 기반의
Building Lighting control system,
Daylight energy saving system,
Occpancy Sensor system 분야에 있어
한발 앞선 기술과 고품질의 제품,
고객만족의 서비스를 자신합니다.

시스템 컨설팅 및 설계, 납품 및 시공의
프로젝트 전 과정에 대한 One-Stop Service로
최상의 파트너가 되도록 노력하겠습니다.



Lighting Management System



Our Solution

BUILDING / Management system
- Encelium Energy saving system

BUILDING / Management system

HOTEL / Switch

OFFICE / RESIDENTIAL

DALI Professional
ENCELIUM EDGE
DALI MCU(Tunable)
BT RTC(Bluetooth)

COMPONENT

1-10V / DALI Driver

Our Partner

OSRAM 
ENCELIUM

SIEMENS

EATON

 **LUTRON**

LITECOM
infinity

OSRAM 





상 호 명 주식회사 에이엘솔루션

설 립 일 2017년 5월 10일

대 표 이 사 박 영 석

업 태 도매업 , 소매업

주요제 품 조명제어 시스템, 조명기구,
 디밍안정기, 조명제어 설계,공급 및 시공

소 재 지 서울특별시 송파구 송파대로
 167 B동 1420호
 (문정동 , 테라타워1)

TEL:02-2054-8966
FAX:02-2054-8967
sales@alsolution.co.kr
webpage:www.alsolution.co.kr

LIGHTING
MANAGEMENT
SYSTEM

-
NH분사 신사옥
인천대학교 (송도)
송도컨벤션센터
한국전력공사 영종사옥
신세계인터네셔널
NIKE SEOUL OFFICE
광명 IKEA
롯데 제주 리조트
벤츠 물류센터
서울미술관
영종도 파라다이스 시티
지하철 9호선 한성백제역사
청담동 셀린느
압구정 Chloe
평택공군기지
하림 신사옥
현대백화점 천호점
GE판교 글로벌 R&D센터
LF 로지스틱스
P&G KOREA 로지스틱스

-
- LONG SON CONTROL BUILDING Technical Building Vietnam HYUNDAI
 - CFP MAB2 Technical Building Fluor & JV
 - Punta del Tigre CCPP PROJECT, Uruguay Hyundai E&C Korea
 - abshan5 Control Building, UAE Hyundai E&C Korea
 - Takreer Refinery Expansion Control Buildig, UAE Samsung E&C Korea
 - Gasco IGD Ruwais Control Building, UAE Petrofac-GS JV
 - Abu Dhabi Gas Industries SGD Control Building, UAE Samsung E&C Korea
 - FERTIL 2 Project Control Building, UAE Samsung E&C Korea
 - Borouge 3 Control Building, UAE Hyundai E&C Korea

LH 한국토지주택공사 진주 사옥
LH Jinju Office Building



OSRAM ENCELIUM® Energy Management System

- Polaris 3D™
- Touch Screen
- Program switch
- Photo Sensor
- Occupancy Sensor
- Switching Panel

초 에너지 절약형 건축물 시스템 구축

- 전력 피크 치 관리기능
- 이산화 탄소 배출 관리
- 개별 조명제어
- 조도, 재실 센서 제어
- 타임스케줄 관리

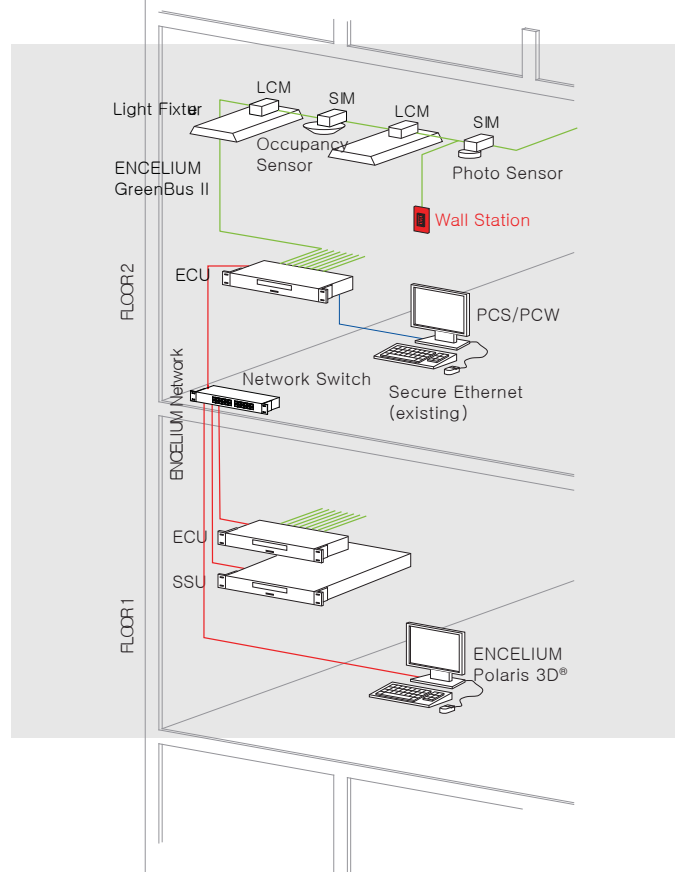

IKEA 광명점
IKEA KOREA GWANGMYEONG CITY



SIEMENS KNX-EIB SYSTEM
BMS Main Control

Photo Sensor
Occupancy Sensor
Switching actuator

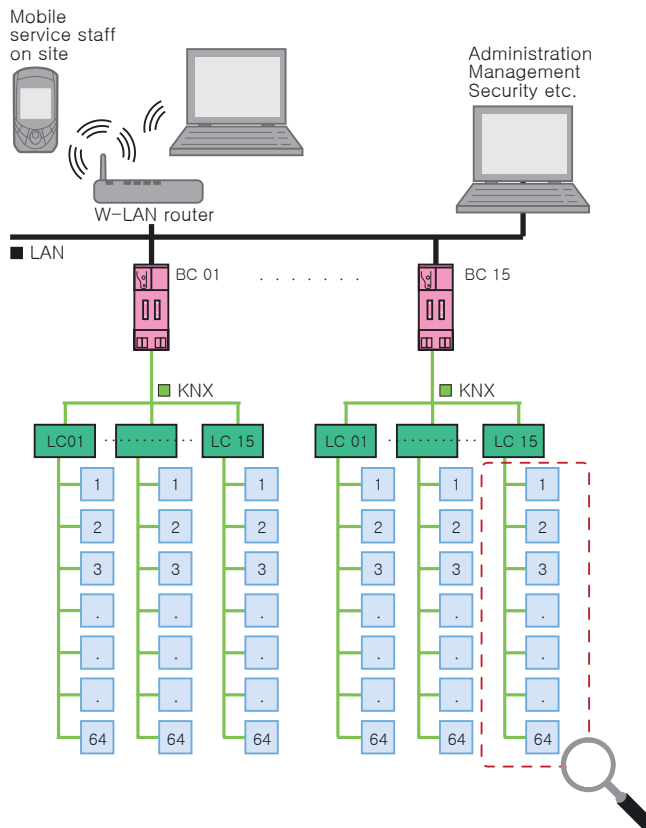

- ▶ Several Area :
 - 최대 확장된 시스템 구조
 - backbone coupler(BC)에 의해 각 Area 연결
 - Main과 Area Line은 각기 자체 PSU가 필요
 - 최대 15*15*64의 디바이스 연결이 가능
- ▶ Area
 - 1 Line이상 15 Line 이하의 시스템
 - Main Line을 통한 Line coupler(LC)의 연결로 가능
 - Main Line 은 자체 PSU가 필요
 - 최대 15*64의 디바이스 연결이 가능
- ▶ Line
 - 가장 작은 시스템 구조
 - 1EA의 Power supply unit(PSU)을 통해
 - 최대 64EA 디바이스 제어

나이키 강남파이낸스 사무실
NIKE SEOUL OFFICE

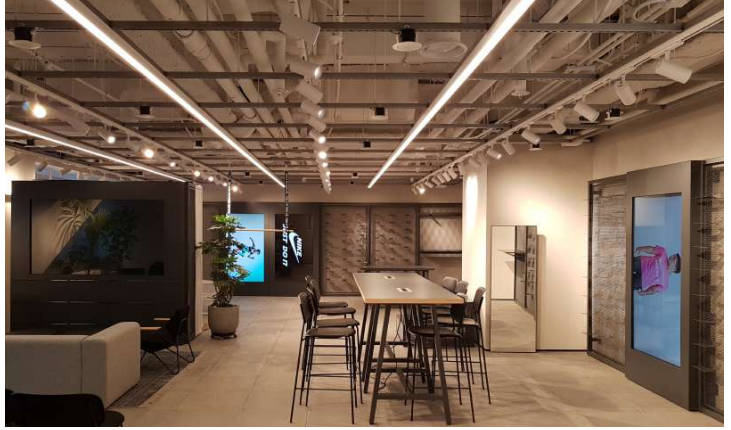

OSRAM ENCELIUM Energy Management System

- Polaris 3D™
- Program switch
- Photo Sensor
- Occupancy Sensor
- Dimming Panel

에너지 절약형 건축물 시스템 구축

- 인텔리전트 시스템 구축
- 조도, 재실 제어
- 타임스케줄 관리

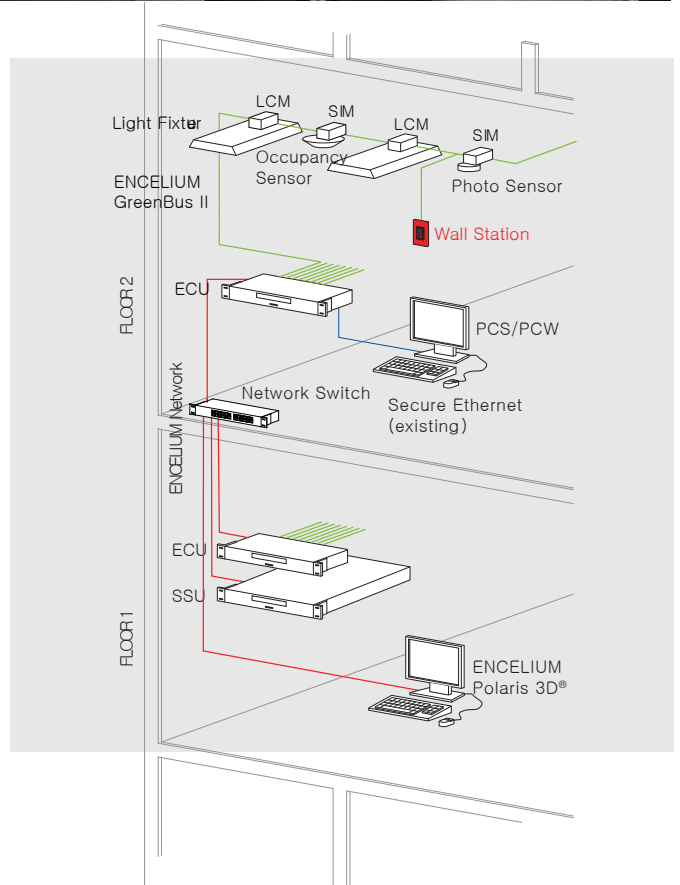

인천대학교 (도시과학대학)
Incheon University



OSRAM ENCELIUM Energy Management System

- Polaris 3D™
- Program switch
- Occupancy Sensor
- Switching Panel

에너지 절약형 건축물 시스템 구축

- 냉난방 재실 센서 관리
- 조도, 재실 제어
- 타임스케줄 관리

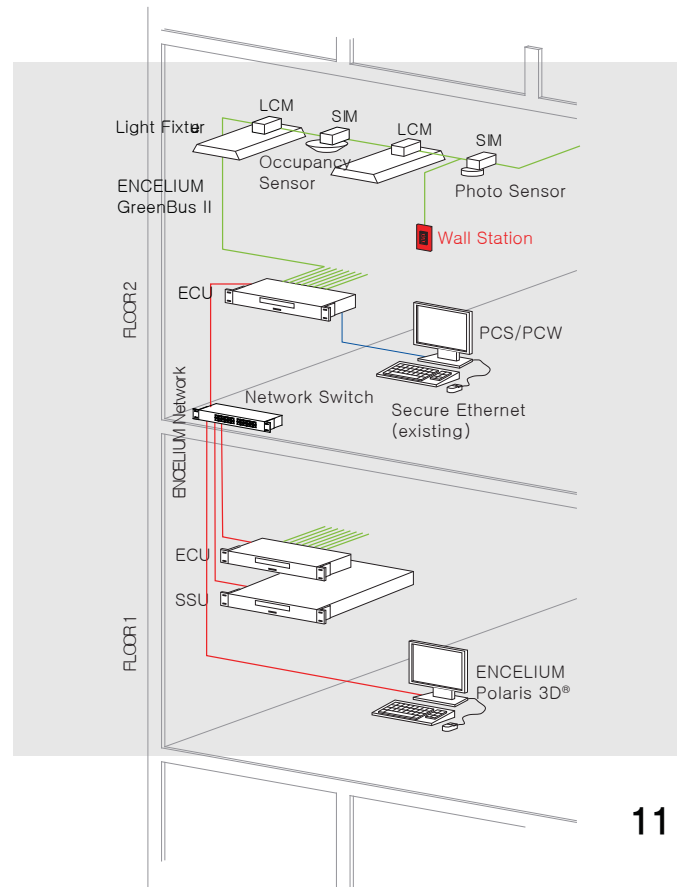

송도 컨벤션센터
Songdo Convensia



SIEMENS AXI-EIB SYSTEM
Occupancy Sensor
Motion Detector

LUTRON SYSTEM

- Energi Savr Node Controller
- Dimming / Scene Control
- Time Schedule Control

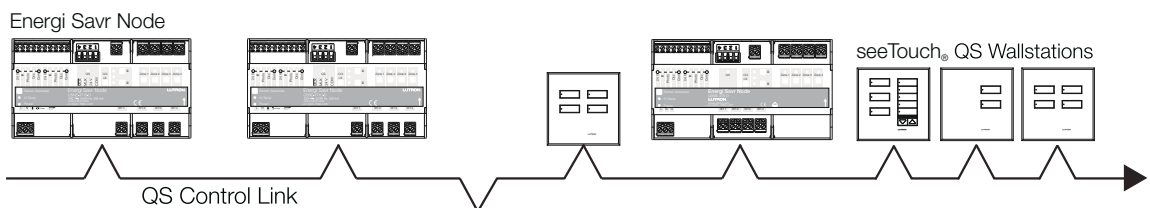
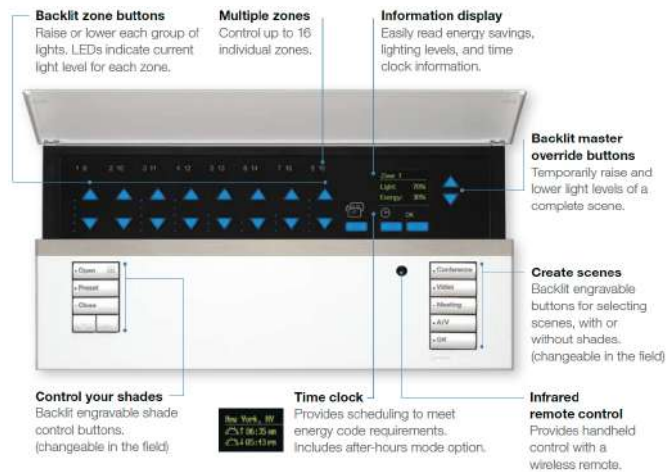

하림 신사옥
HARIM Office Building



OSRAM ENCELIUM Energy Management System

- Polaris 3D™
- Program switch
- Photo Sensor
- Occupancy Sensor
- Switching Panel

초 에너지 절약형 건축물 시스템 구축

- 전력 피크 치 관리기능
- 이산화 탄소 배출 관리
- 개별 조명제어
- 조도, 재실 센서 제어
- 타임스케줄 관리

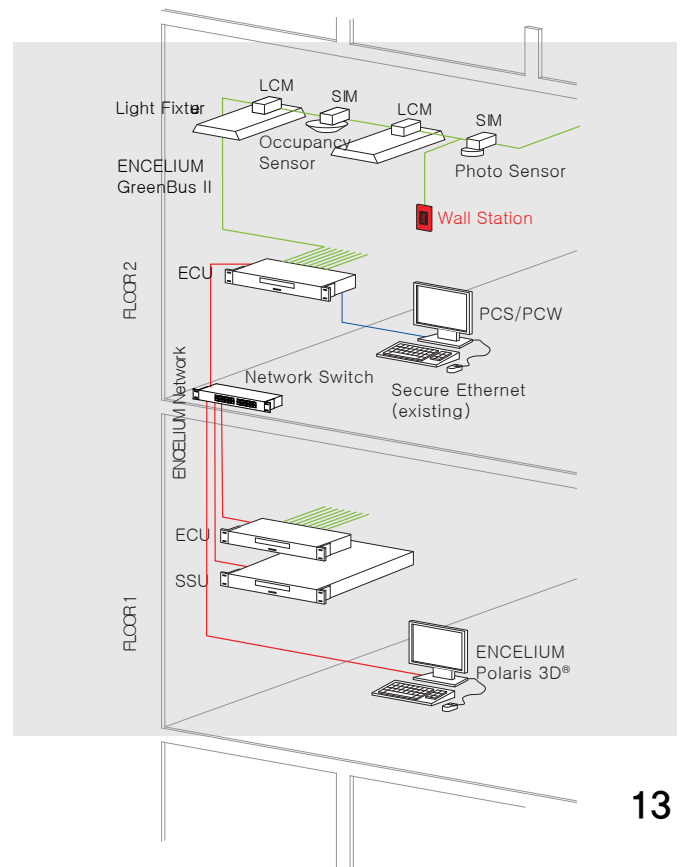

LF 로지스틱스 물류센터
LF Logistics Warehouse



SIEMENS KNX-EIB SYSTEM

Occupancy Sensor
Switching actuator

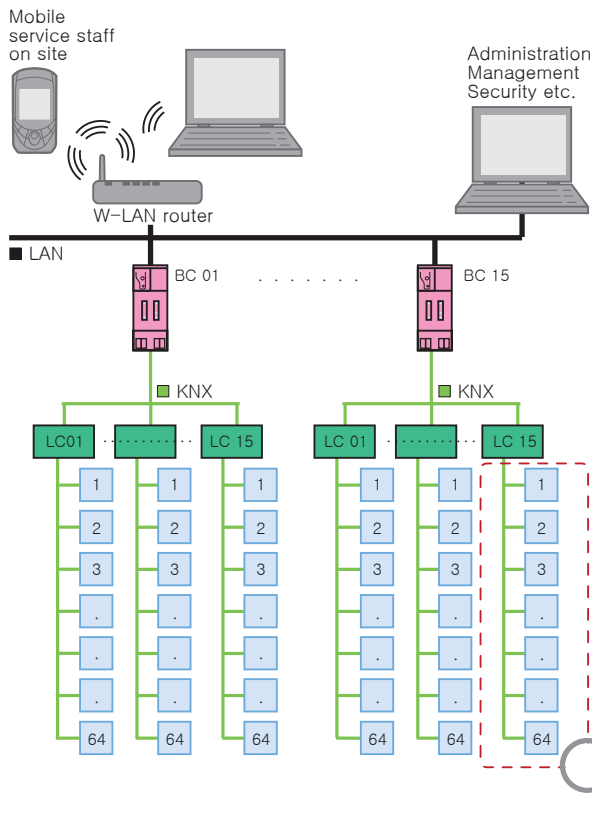

- ▶ Several Area :
최대 확장된 시스템 구조
backbone coupler(BC)에 의해 각 Area 연결
Main과 Area Line은 각기 자체 PSU가 필요
최대 15*15*64의 디바이스 연결이 가능
- ▶ Area
1 Line이상 15 Line 이하의 시스템
Main Line을 통한 Line coupler(LC)의 연결로 가능
Main Line 은 자체 PSU가 필요
최대 15*64의 디바이스 연결이 가능
- ▶ Line
가장 작은 시스템 구조
1EA의 Power supply unit(PSU)을 통해
최대 64EA 디바이스 제어

벤츠 BTS물류센터
Mercedes-BENZ BTS Warehouse

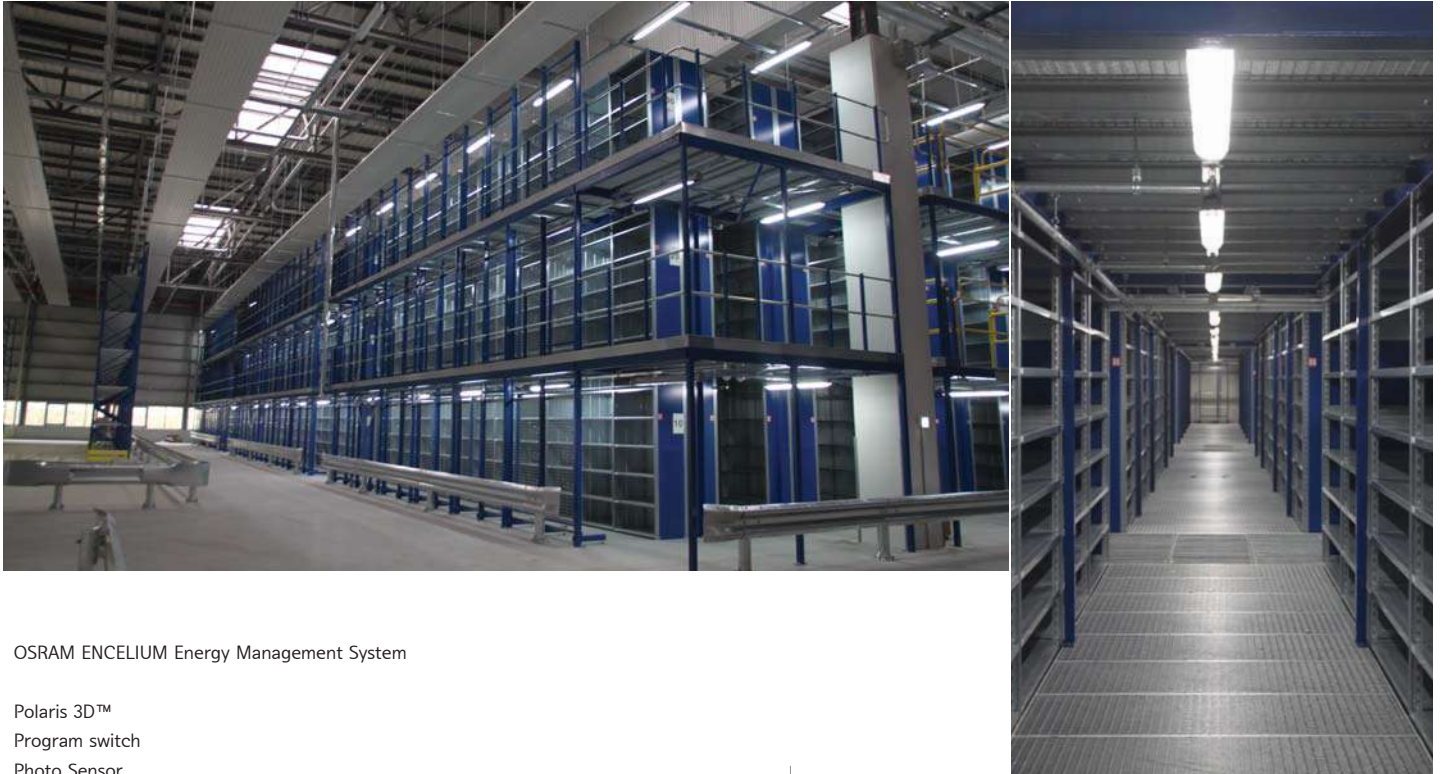

OSRAM ENCELIUM Energy Management System

- Polaris 3D™
- Program switch
- Photo Sensor
- Occupancy Sensor
- Switching Panel

에너지 절약형 건축물 시스템 구축

- 전력 피크 치 관리기능
- 이산화 탄소 배출 관리
- 조도, 재실 센서 제어
- 타임스케줄 관리

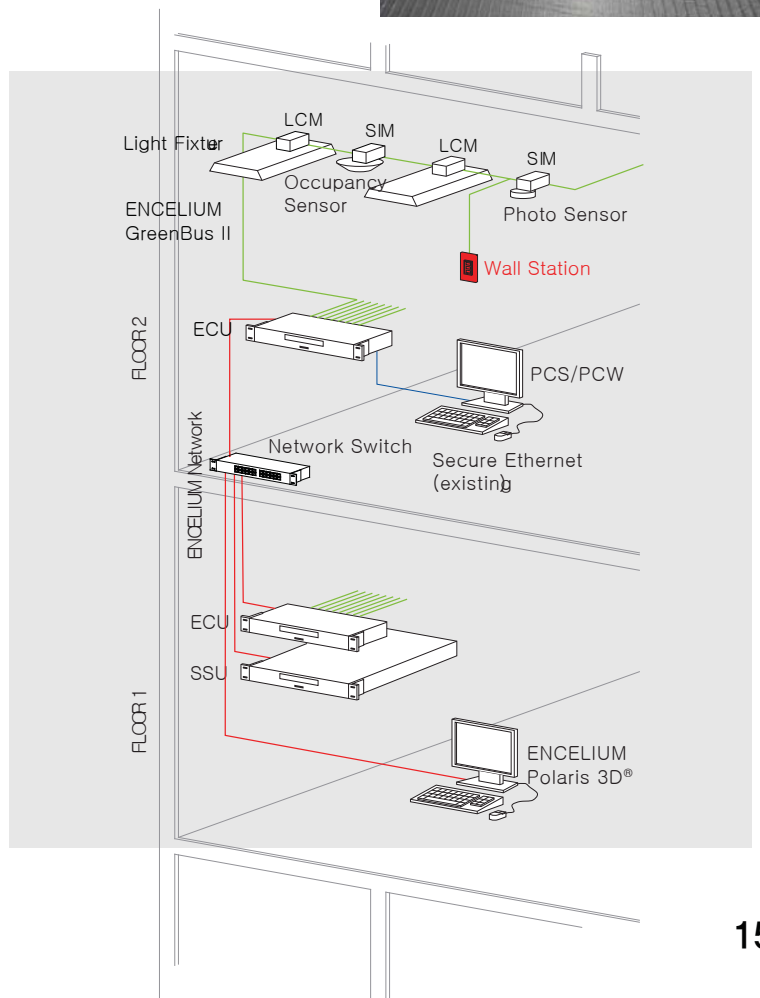

지하철 9호선 한성백제역
Hansung Baekje Station

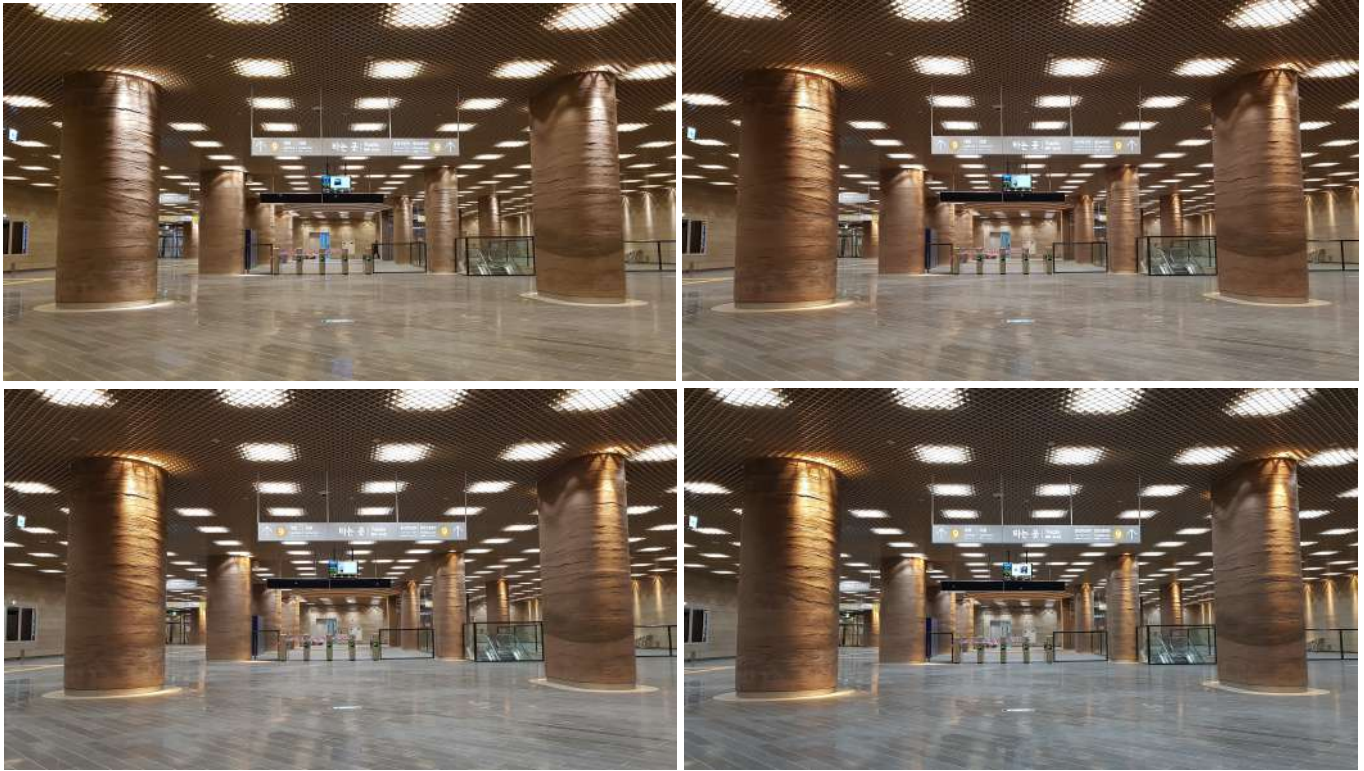

OSRAM ENCELIUM Energy Management System

- Polaris 3D™
- Program switch
- Photo Sensor
- Occupancy Sensor
- Switching Panel

외부 실시간 색온도 변환시스템 구축

- 전력 피크 치 관리기능
- 이산화 탄소 배출 관리
- 실시간 색 온도 연출제어
- 타임스케줄 관리

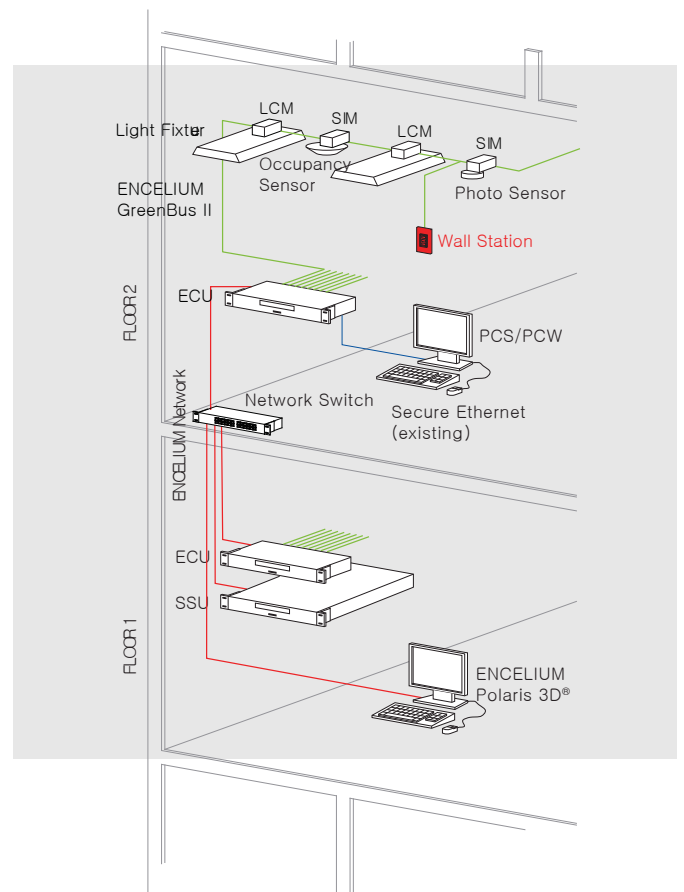

한국전력 영종도 지사
KEPCO Yeongjongdo



OSRAM ENCELIUM Energy Management System

- Polaris 3D™
- Program switch
- Occupancy Sensor
- Switching Panel

에너지 절약형 건축물 시스템 구축

- 냉난방 제실 센서 관리
- 조도, 재실 제어
- 타임스케줄 관리

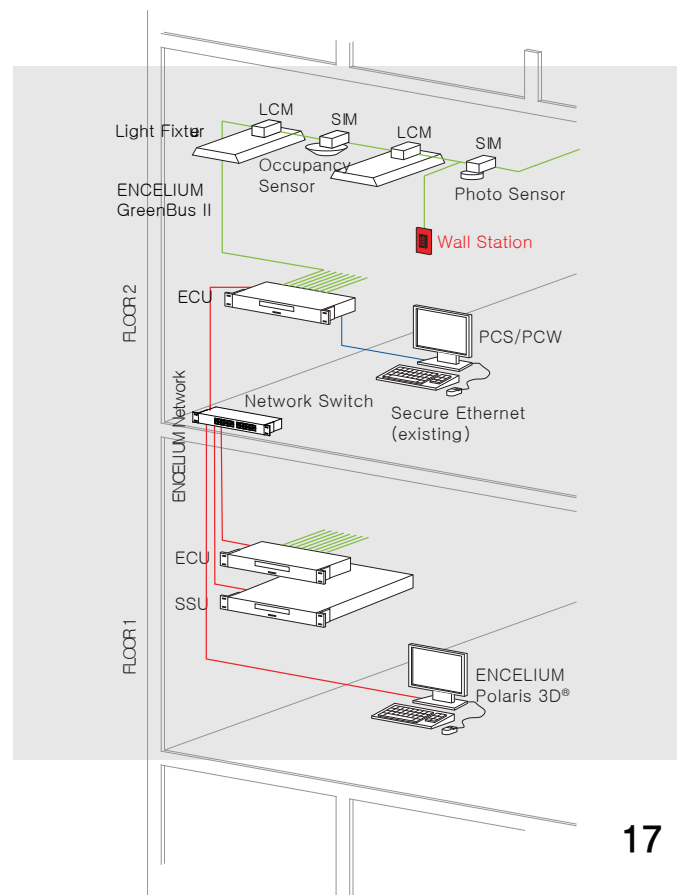

제주 롯데 리조트
Jeju LOTTE Resort



아트빌라스 73세대

SIEMENS KNX-EIB system

Program switch

IR Remote Controller

DALI gateway

Halogen dimmer

OSRAM DALI Ballast

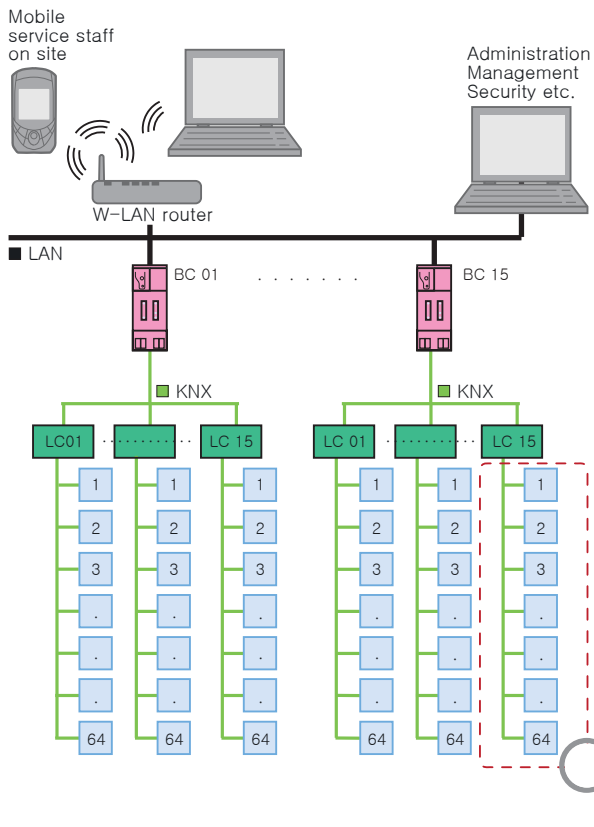

해외 프로젝트

- LONG SON Control Building, VietnamKuwait, HYUNDAI
- CFP MAB2 Technical Building, Kuwait
- Fluor & DAEWOO & HYUNDAI JV Korea Punta del Tigre CCPP PROJECT, Uruguay Hyundai E&C Korea
- Gasco IGD Habshan Control Building, UAE Hyundai E&C Korea
- Takreer Refinery Expansion Control Building, UAE Samsung E&C Korea
- Gasco IGD Ruwais Control Building, UAE Petrofac-GS JV Korea
- Abu Dhabi Gas Industries SGD Control Building, UAE Samsung E&C Korea
- FERTIL 2 Project Control Building, UAE Samsung E&C Korea
- Borouge 3 Control Building, UAE Hyundai E&C Korea

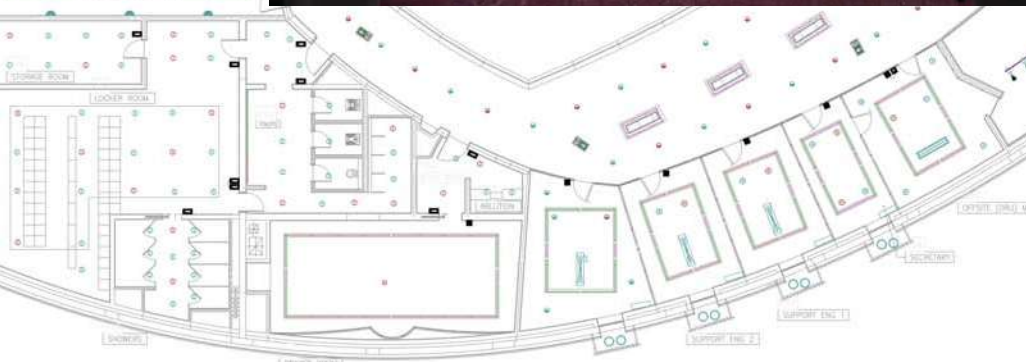
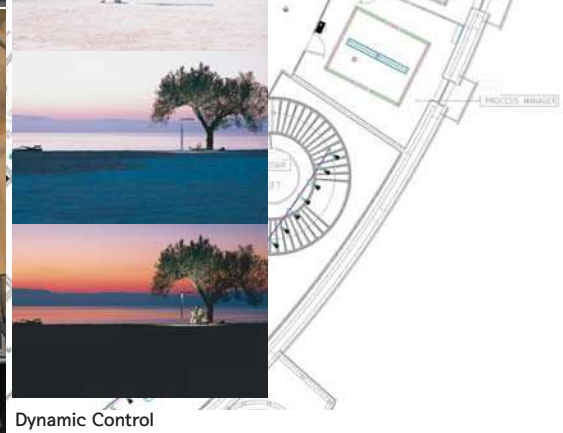
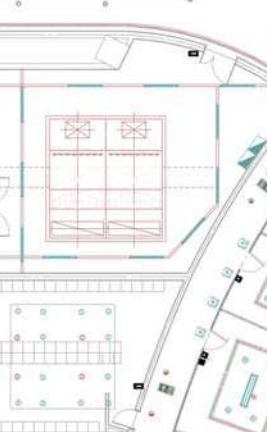
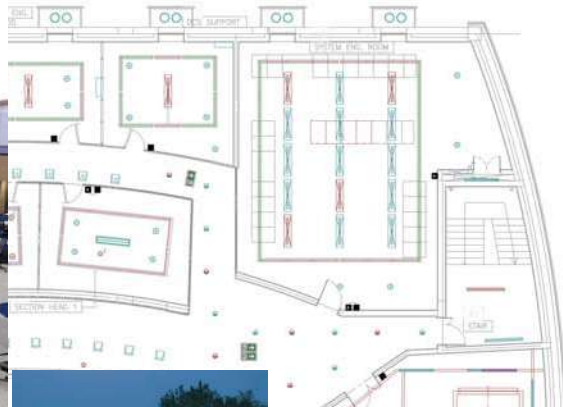
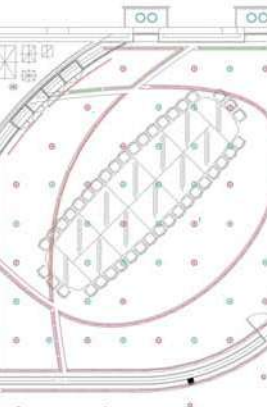

Dynamic Control
조명의 밝기와 방향 그리고 색온도를 하루 주기의 자연광(Daylight)과 최대한 유사한 조명환경으로 인체의 생체리듬(Bio-rhythm)에 부합하는 친 인간적인 조명환경을 구현

- 인간의 생물학적 시계를 맞춰주는 조명환경
- 에너지 자원감소 시대에 효율적인 조명제어를 통하여 에너지 효율 극대화
- 조명방식의 지능화로 다양한 환경에 적합한 조명연출

영종도 파라다이스 시티
PARADISE CITY



LITECOM infinity
System CCD Controller
Touch Screen Switch

- DALI CONTROL SYSTEM
- Touch Screen
 - Tunable White Control
 - DYNAMIC Change Control

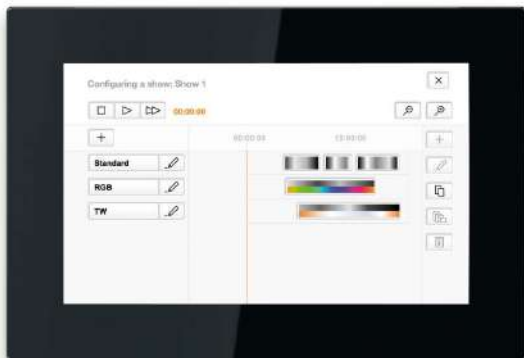

현대백화점(천호점)
HYUNDAI Department Store



SIEMENS KNX-EIB SYSTEM

Switching Dimming actuator
Time Schedule
Touch Screen

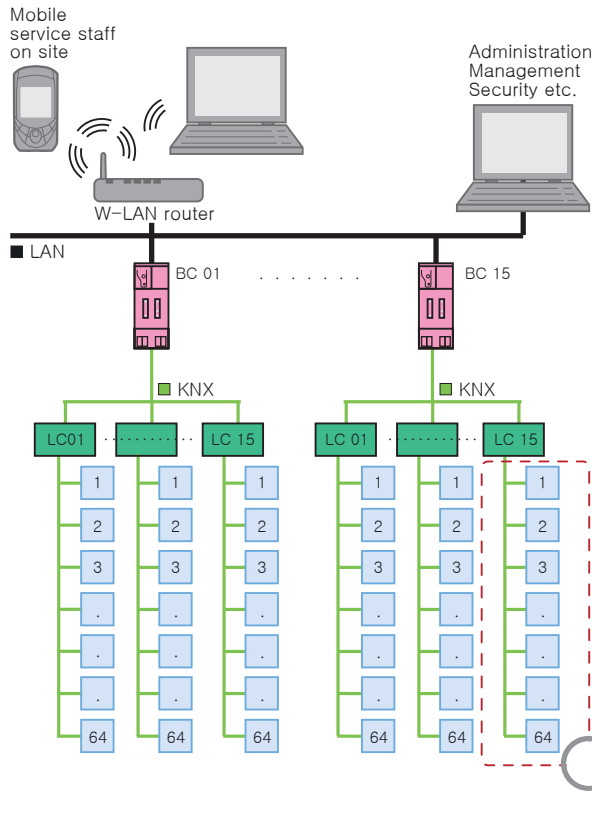

- ▶ Several Area :
 - 최대 확장된 시스템 구조
 - backbone coupler(BC)에 의해 각 Area 연결
 - Main과 Area Line은 각기 자체 PSU가 필요
 - 최대 15*15*64의 디바이스 연결이 가능
- ▶ Area
 - 1 Line이상 15 Line 이하의 시스템
 - Main Line을 통한 Line coupler(LC)의 연결로 가능
 - Main Line 은 자체 PSU가 필요
 - 최대 15*64의 디바이스 연결이 가능
- ▶ Line
 - 가장 작은 시스템 구조
 - 1EA의 Power supply unit(PSU)을 통해
 - 최대 64EA 디바이스 제어

셀린느 청담점
CELINE STORE



LUTRON SYSTEM

GRAFIK Eye QS DALI controller

- Dimming / Scene Control
- Time Schedule Control

Backlit zone buttons
Raise or lower each group of lights. LEDs indicate current light level for each zone.

Multiple zones
Control up to 16 individual zones.

Information display
Easily read energy savings, lighting levels, and time clock information.

Backlit master override buttons
Temporarily raise and lower light levels of a complete scene.

Create scenes
Backlit engravable buttons for selecting scenes, with or without shades. (changeable in the field)

Control your shades
Backlit engravable shade control buttons. (changeable in the field)

Time clock
Provides scheduling to meet energy code requirements. Includes after-hours mode option.

Infrared remote control
Provides handheld control with a wireless remote.



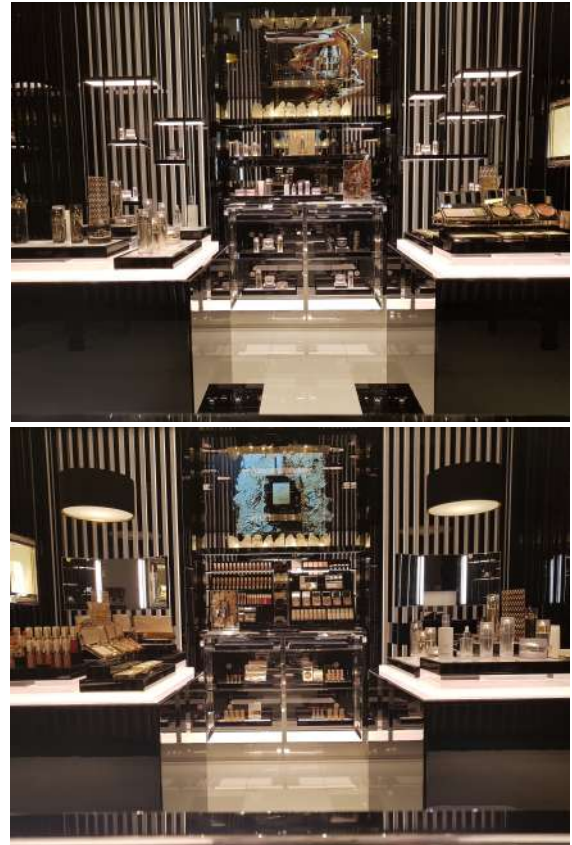

LUTRON SYSTEM

- Energi Savr Node Controller
 - Dimming / Scene Control
 - Time Schedule Control

Backlit zone buttons
Raise or lower each group of lights. LEDs indicate current light level for each zone.

Multiple zones
Control up to 16 individual zones.

Information display
Easily read energy savings, lighting levels, and time clock information.

Backlit master override buttons
Temporarily raise and lower light levels of a complete scene.

Create scenes
Backlit engravable buttons for selecting scenes, with or without shades. (changeable in the field)

Control your shades
Backlit engravable shade control buttons. (changeable in the field)

Time clock
Provides scheduling to meet energy code requirements. Includes after-hours mode option.

Infrared remote control
Provides handheld control with a wireless remote.

Energi Savr Node

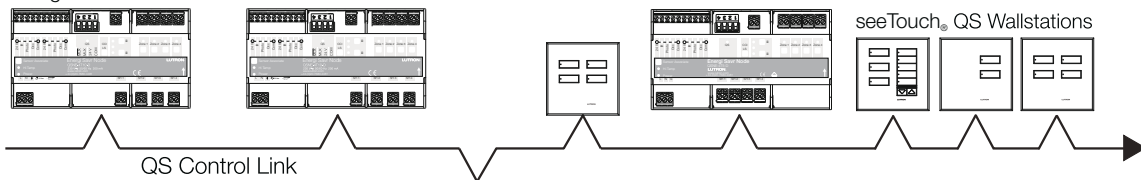



Constans Current LED drivers



Product description - DALI NFC DRIVER

- OTi DALI 10/220...240/700 NFC

- OTi DALI 15/220...240/1A0 LT2 NFC

- OTi DALI 25/220...240/700 LT2 NFC

- OTi DALI 35/220...240/1A0 LT2 NFC

- OTi DALI 50/220...240/1A4 LT2 FAN NFC



Product description - DALI NFC DRIVER

- OTi DALI 25/220...240/700 NFC L

- OTi DALI 35/220...240/1A0 LT2 NFC L

- OTi DALI 50/220...240/1A4 LT2 NFC L



Product description - DALI Tunable White

- OTi DALI 35/220...240/700 NFC TW L

- OTi DALI 75/220...240/1A4 LT2 NFC TW L



Product description - Track ON/OFF 2/4PIN

- OT FIT 20/220...240/500 CS T-W/B/G -4PIN

- OT FIT 30/220...240/800 CS T-W/B/G -4PIN

- OT FIT 40/220...240/1A0 CS T-W/B/G -4PIN

- OT FIT 20/220...240/500 CS T-W/B/G -2PIN

- OT FIT 30/220...240/700 CS T-W/B/G -2PIN

- OT FIT 38/220...240/900 CS T-W/B/G -2PIN



Product description - ON/OFF MINI SIZE

- OT FIT 8/220...240/180 CS S MINI

- OT FIT 15/220...240/350 CS S MINI

- OT FIT 20/220...240/500 CS S MINI

- OT FIT 30/220...240/700 CS S MINI

- OT FIT 38/220...240/900 CS S MINI



Constans Voltage LED drivers



Product description - DALI DRIVER

- OTi DALI 50/220...240/24 1...4CH

- OTi DALI 80/220...240/24 1...4CH

- OTi DALI 160/220...240/24 1...4CH



Product description - DALI IP 67 DRIVER

- OTi DALI 100/220...240/24 1...4CH P

- OTi DALI 210/220...240/24 1...4CH



Product description - DALI Tunable White

- OTi DALI 50/220...240/24 1...4CH TW

- OTi DALI 80/220...240/24 1...4CH TW

- OTi DALI 160/220...240/24 1...4CH TW



Product description - 1-10V IP 66&67 DRIVER

- OT 20/220...240/24 DIM P

- OT 40/220...240/24 DIM P

- OT 60/220...240/24 DIM P

- OT 100/220...240/24 DIM P

- OT 130/220...240/24 DIM P

- OT 250/220...240/24 DIM P



Product description - ON/OFF 24V

- ELEMENT 30/220...240/24 G2

- ELEMENT 60/220...240/24 G2

- ELEMENT 120/220...240/24 G2

- ELEMENT 180/220...240/24 G2

LIGHTING MANAGEMENT

AL SOLUTION

주식회사 에이엘솔루션
서울특별시 송파구 송파대로 167
테라타워1 B동 1420호

Tel 02 2054 8966
Fax 02 2054 8967

sales@alsolution.co.kr
www.alsolution.co.kr